

ALBED

M I L A N O 1 9 6 4

MANUALE TECNICO
Porte battenti

AND

PORTA BATTENTE - VERSIONE A TIRARE

PORTA BATTENTE

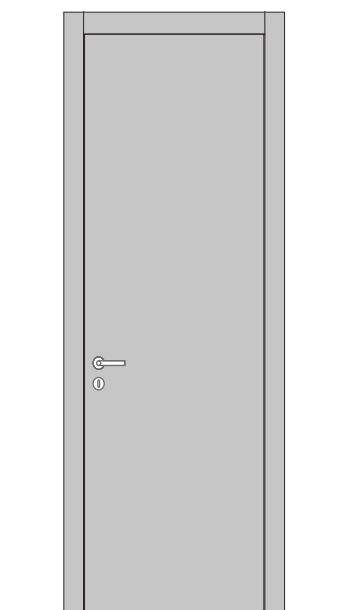
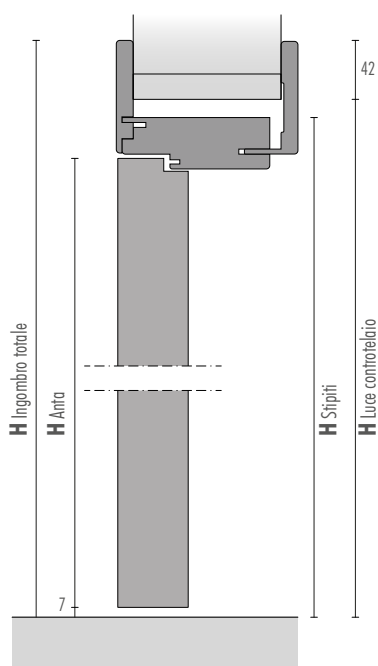
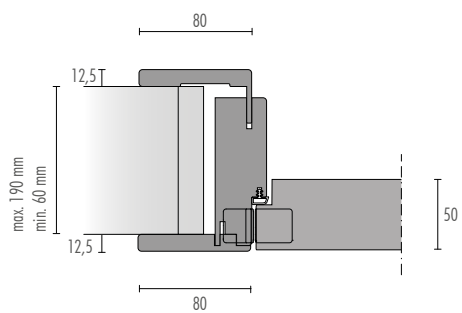

DISTINTA COMPONENTI

N.B.: Le porte sono incernierate con cerniere invisibili su stipiti telescopici in grado di tollerare spessori di muri variabili da 60 a 190 mm. La cerniera è regolabile e permette l'apertura dell'anta di 180 gradi. Le porte non sono reversibili.

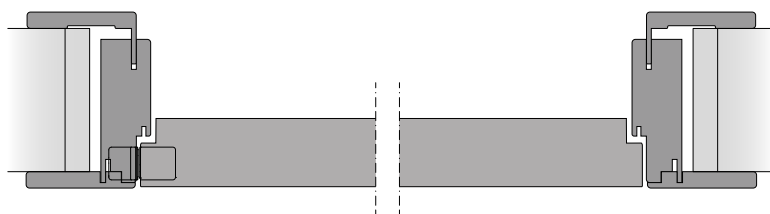
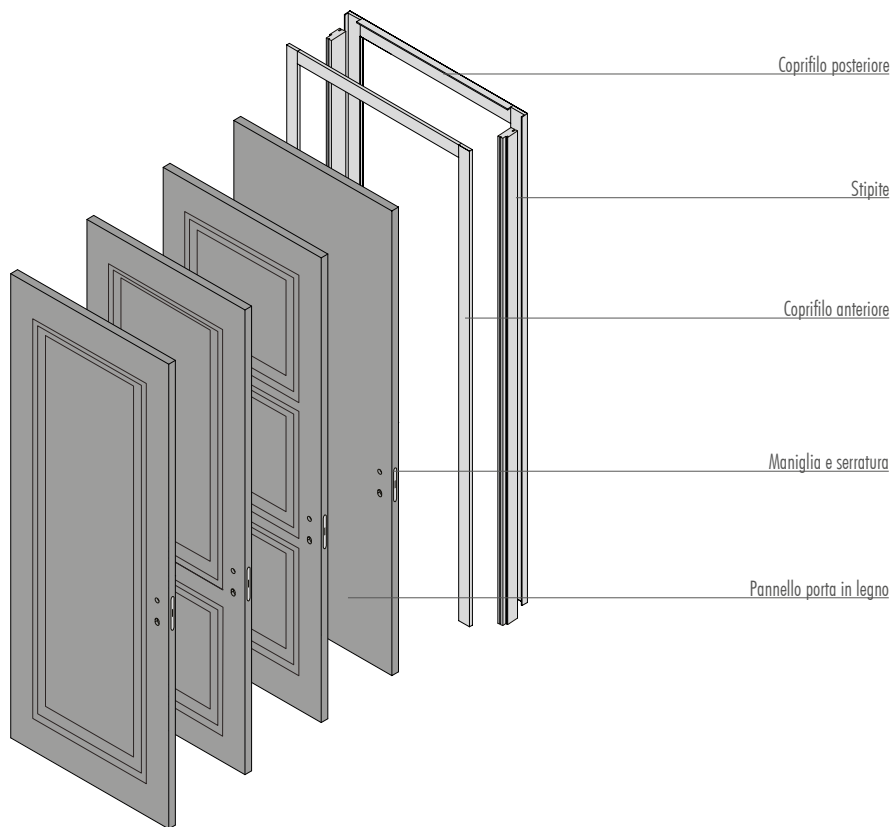

APERTURA SINISTRA

N.B.: Le porte non sono reversibili.

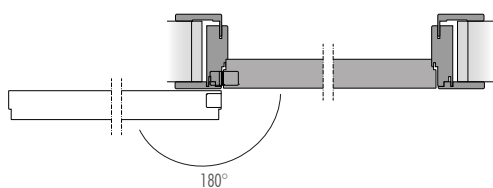

APERTURA DESTRA

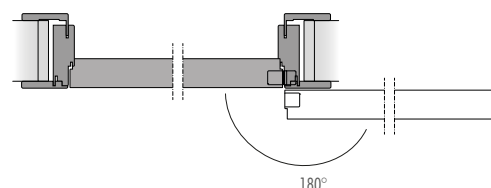

INDICAZIONI PER L'ORDINE

- 1- Luce controtelaio in larghezza L
- 2- Luce controtelaio in altezza H
- 3- Spessore del muro Sp
- 4- Ordinare la porta
- 5- Ordinare a parte la serratura

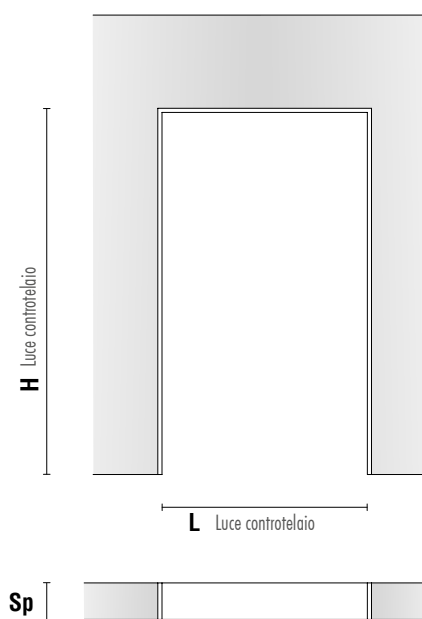
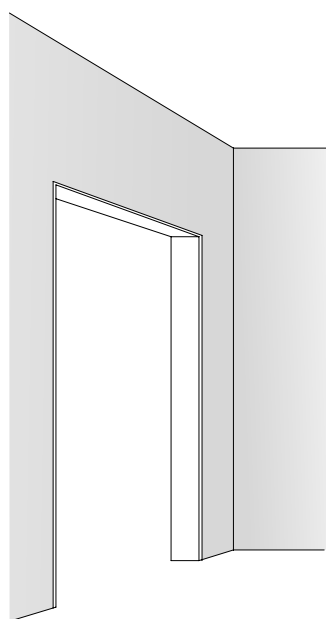

TOLLERANZE - Il sistema di regolazione degli stipiti permette una tolleranza, rispetto alle MISURE STANDARD della Luce controtelaio, di:

Larghezza	+ 10 mm - 10 mm
Altezza	+ 10 mm - 10 mm

N.B.: Le porte si intendono "standard" quando le misure rilevate dei controtelai rientrano nelle tolleranze indicate.
Esempio: controtelaio L890 H2150. Misure tollerate da L880 a L900, da H2140 a H2160.

Luce controtelaio standard			
L (mm)		H (mm)	
790	+10 -10	2150	+10 -10
890	+10 -10	2150	+10 -10

PORTA BATTENTE (TIRARE)

PORTA BATTENTE A TIRARE

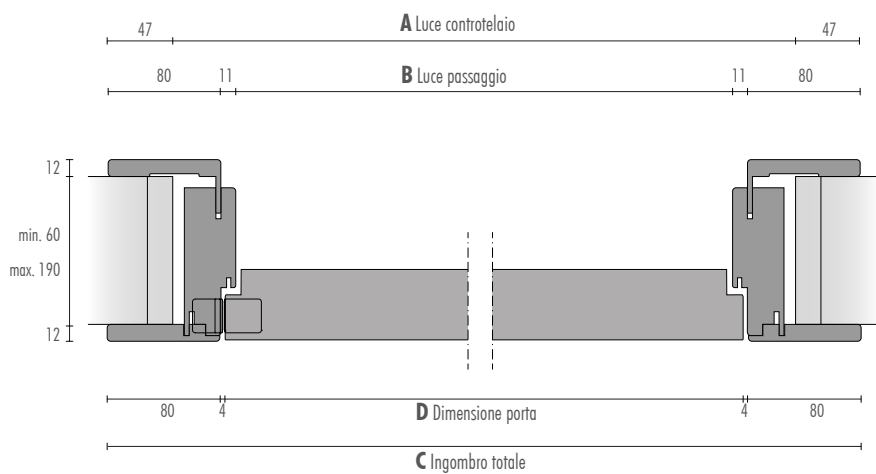
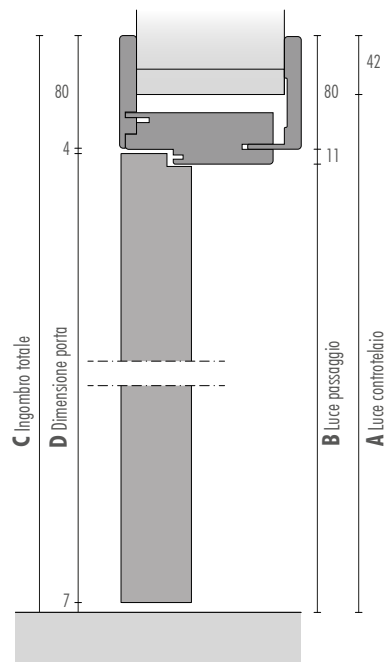
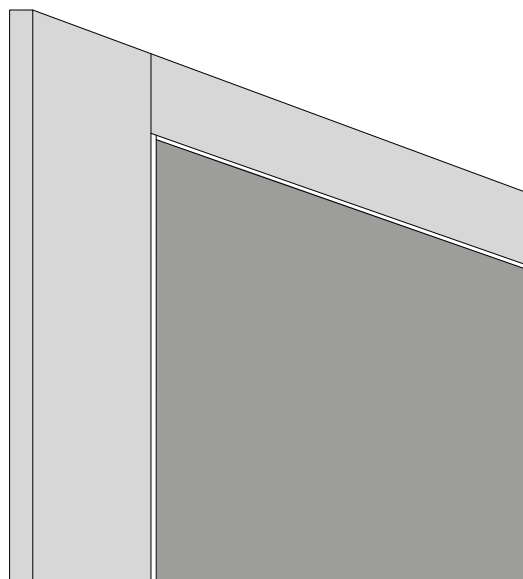

	A Luce controtelaio		B Luce passaggio		C Ingombro totale		D Dimensioni porta	
	L (mm)	H (mm)	L (mm)	H (mm)	L (mm)	H (mm)	L (mm)	H (mm)
Porte standard	790	2150	700	2100	884	2192	714	2100
	890	2150	800	2100	984	2192	814	2100
Porte su misura	max 990	max 2700	900	2650	1084	2742	914	2650

SERRATURE MAGNETICHE PER MANIGLIE CLIENTI



Serratura da incasso: versione con chiave

LV-PS1



Serratura da incasso: versione "libero/occupato" con quadro da 6 mm

LV-PS2



Serratura da incasso: versione a cilindro tipo Yale (cilindro non fornito)

LV-PS3

CARATTERISTICHE GENERALI

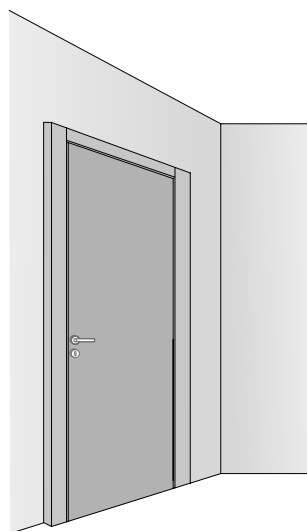

-Telaio anta in legno.

-Specchiatura ante in legno è in tamburato 50 mm.

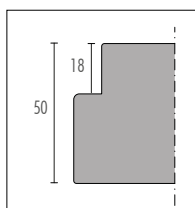

sp. legno

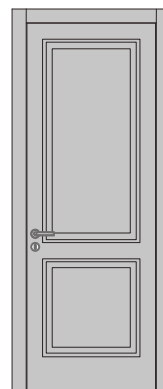
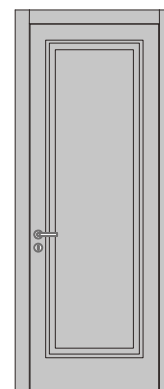
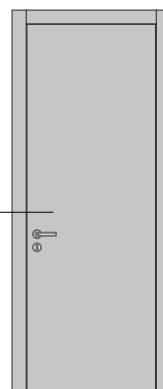

PORTA BATTENTE (TIRARE): AGGIUSTAGGI

AGGIUSTAGGI STIPITI

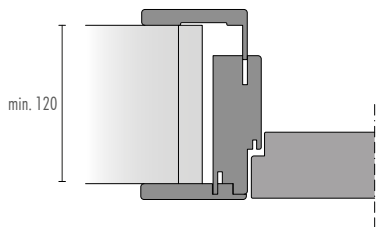

per muri sp. min. 120 mm

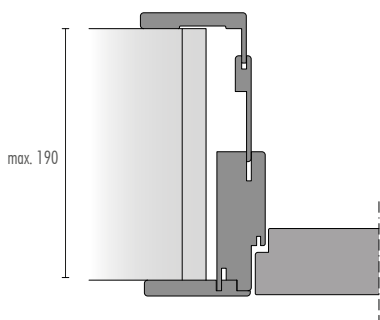

per muri sp. max. 190 mm

RIFILI STIPITI

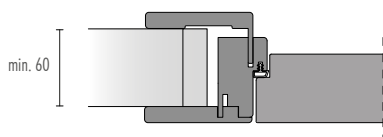

per muri sp. min. 60 mm

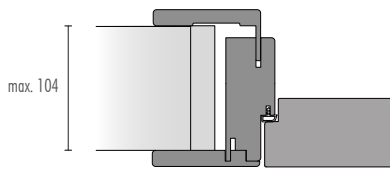

per muri sp. max. 104 mm

AGGIUSTAGGIO STIPITI PER MURI DI SPESSORE MAGGIORE A 120 mm

N.B.: La fascia di aggiustaggio, per muri di spessore maggiore a 120 mm, si inserisce tra gli stipiti.

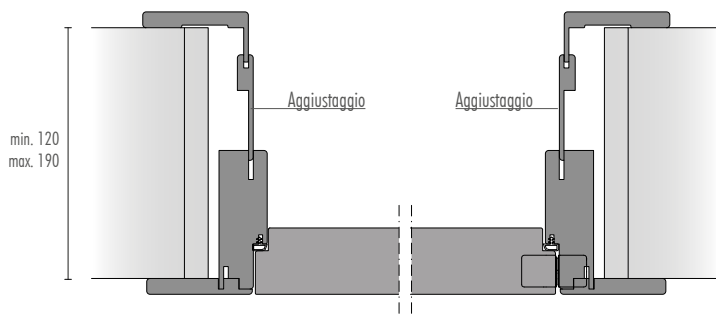
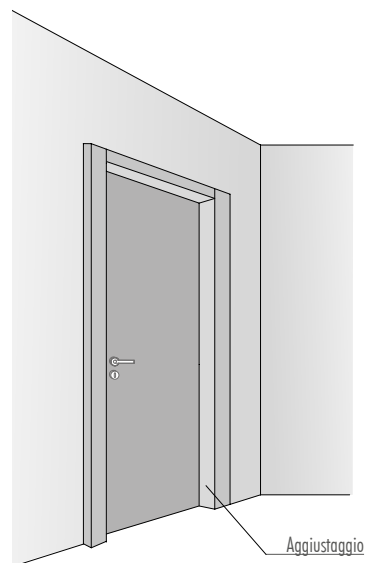
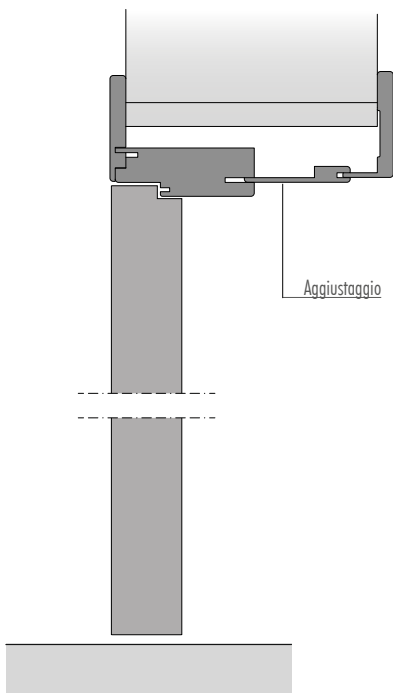

RIFILO STIPITI PER MURI DI SPESSORE INFERIORE A 105 mm

INDICAZIONE PER L' ORDINE:
Indicare spessore del muro

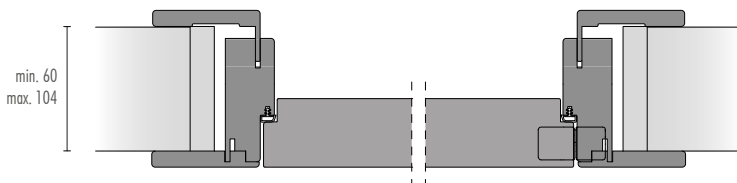

PORTA BATTENTE

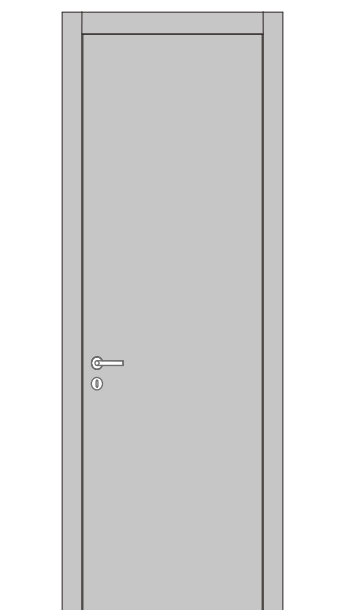
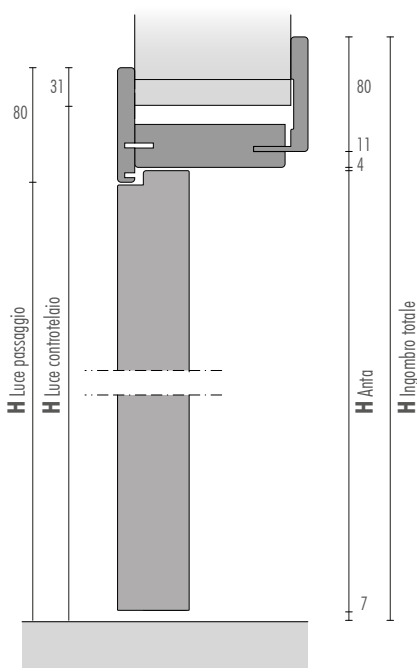
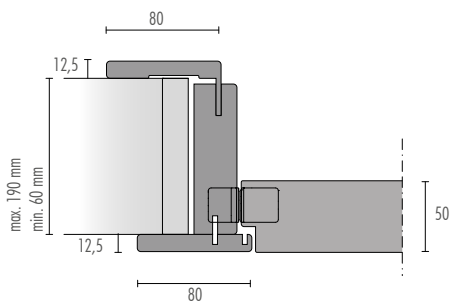

DISTINTA COMPONENTI

N.B.: Le porte sono incernierate con cerniere invisibili su stipiti telescopici in grado di tollerare spessori di muri variabili da 60 a 190 mm. La cerniera è regolabile e permette l'apertura dell'anta di 90 gradi.

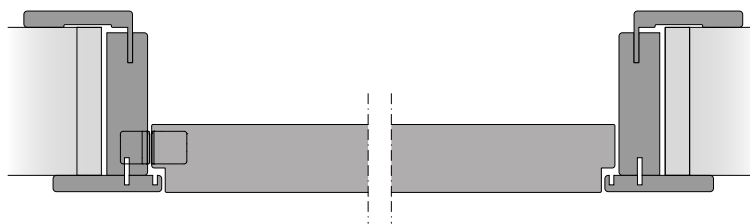
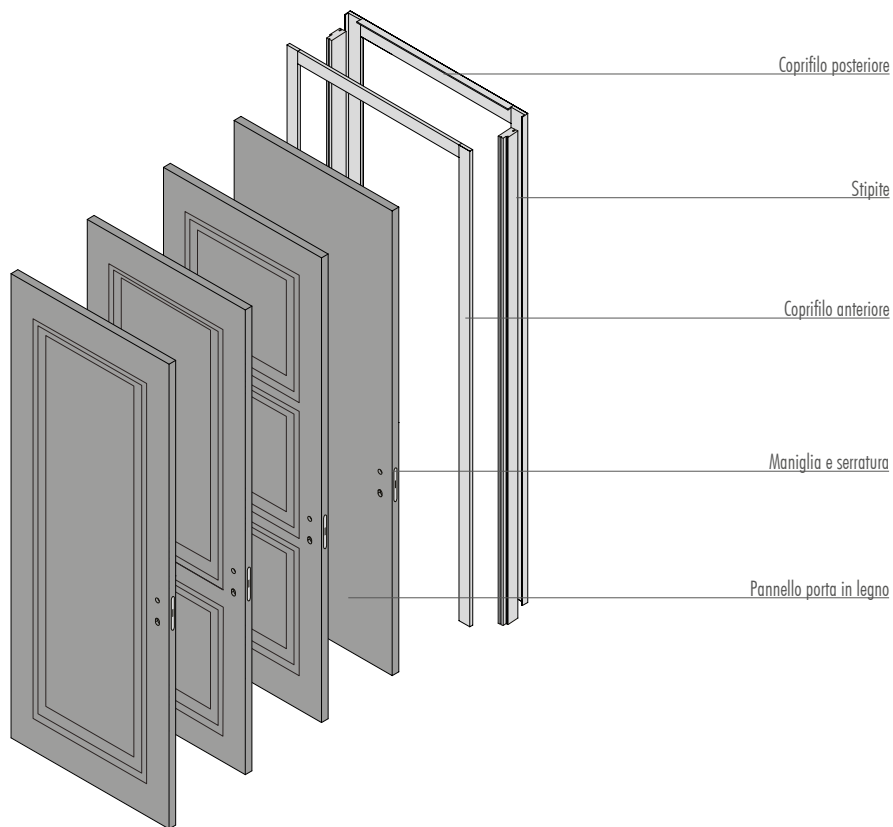

PORTA BATTENTE (SPINGERE)

APERTURA SINISTRA

N.B.: Le porte non sono reversibili.

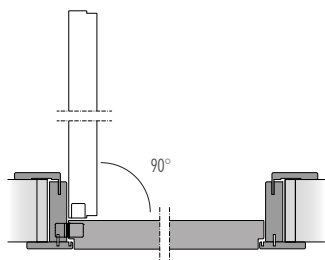

APERTURA DESTRA

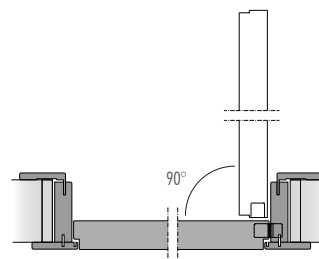

INDICAZIONI PER L'ORDINE

- 1- Luce controtelaio in larghezza L
- 2- Luce controtelaio in altezza H
- 3- Spessore del muro Sp
- 4- Ordinare la porta
- 5- Ordinare a parte la serratura

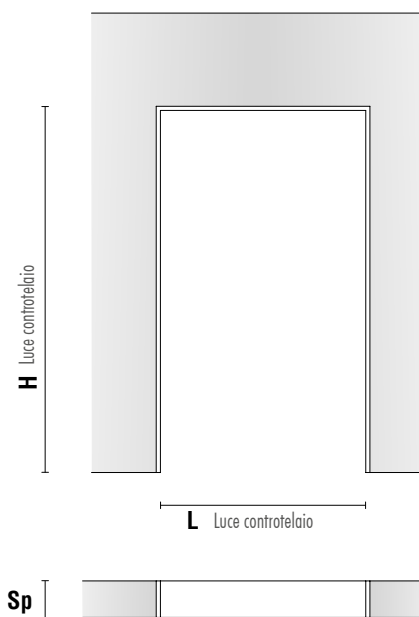
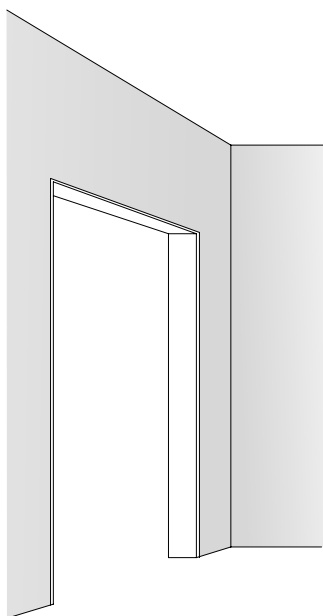

TOLLERANZE - Il sistema di regolazione degli stipiti permette una tolleranza, rispetto alle MISURE STANDARD della Luce controtelaio, di:

Larghezza	+ 10 mm - 5 mm
Altezza	+ 10 mm - 5 mm

N.B.: Le porte si intendono "standard" quando le misure rilevate dei controtelai rientrano nelle tolleranze indicate.
Esempio: controtelaio L890 H2150. Misure tollerate da L885 a L900, da H2145 a H2160.

Luce controtelaio standard			
L (mm)		H (mm)	
790	+10 - 5	2150	+10 - 5
890	+10 - 5	2150	+10 - 5

PORTA BATTENTE A SPINGERE

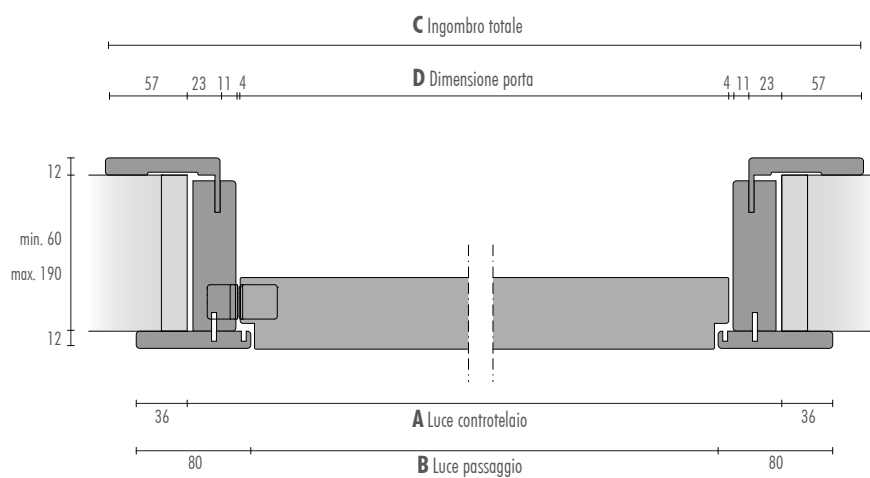
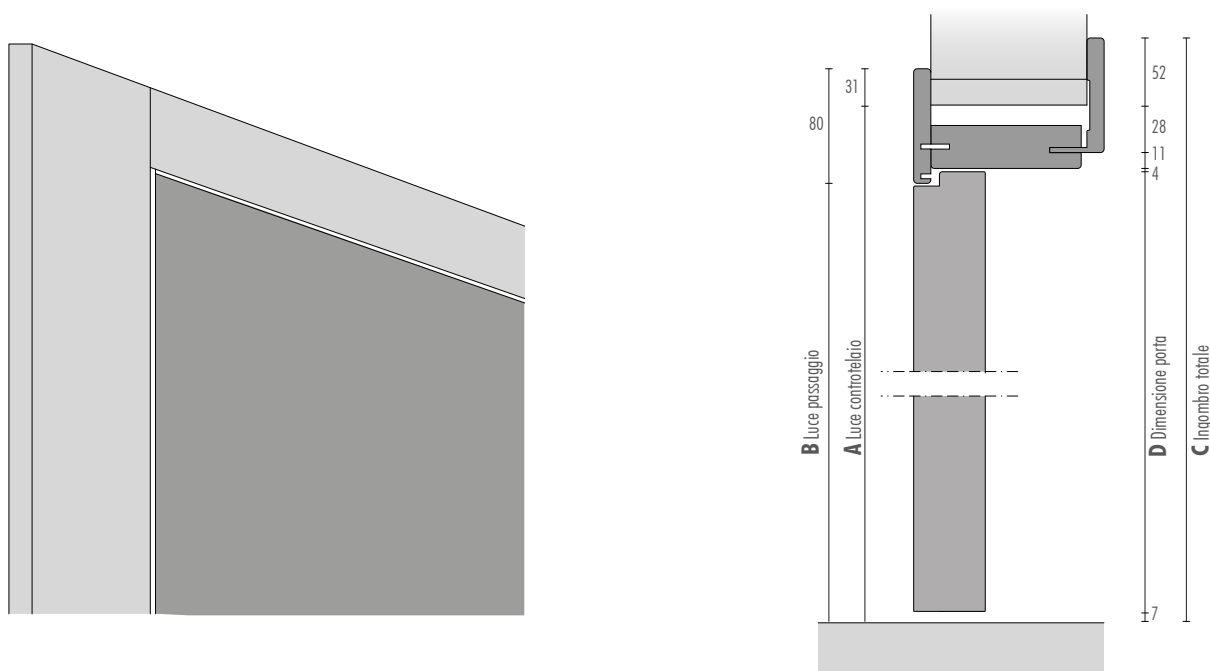

	A Luce controlaio		B Luce passaggio		C Ingombro totale		D Dimensioni porta	
	L (mm)	H (mm)	L (mm)	H (mm)	L (mm)	H (mm)	L (mm)	H (mm)
Porte standard	790	2150	701	2101	904	2202	714	2100
	890	2150	801	2101	1004	2202	814	2100
Porte su misura	max 990	max 2700	901	2651	1104	2802	914	2650

PORTA BATTENTE (SPINGERE): CARATTERISTICHE

SERRATURE MAGNETICHE PER MANIGLIE CLIENTI



Serratura da incasso: versione con chiave

LV-PS1



Serratura da incasso: versione "libero/occupato" con quadro da 6 mm

LV-PS2



Serratura da incasso: versione a cilindro tipo Yale (cilindro non fornito)

LV-PS3

CARATTERISTICHE GENERALI

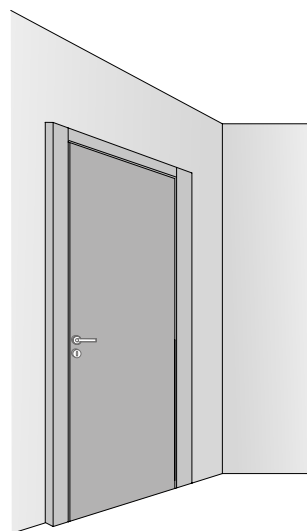

-Telaio anta in legno.

-Specchiatura ante in legno è in tamburato 50 mm.

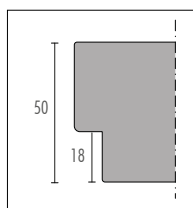

sp. legno

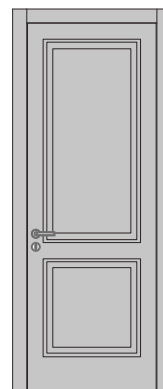
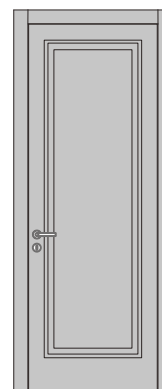
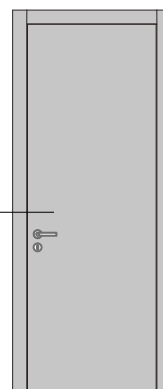

AGGIUSTAGGI STIPITI

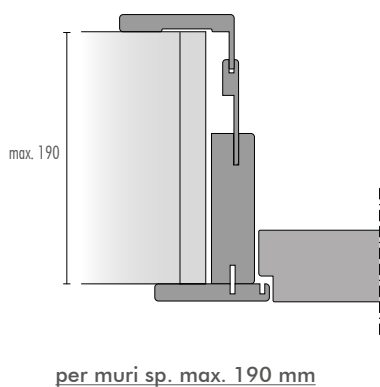
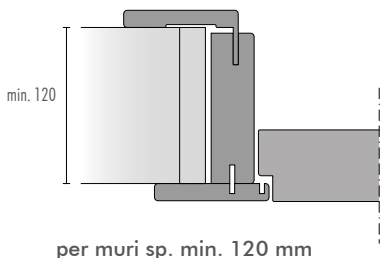

RIFILI STIPITI

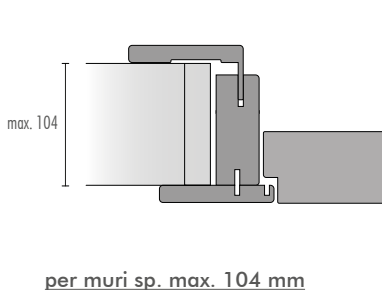
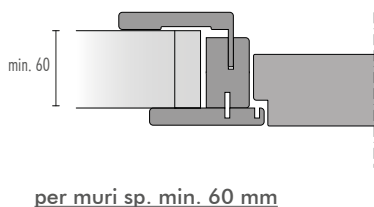

AGGIUSTAGGIO STIPITI PER MURI DI SPESSORE MAGGIORE A 120 mm

N.B.: La fascia di aggiustaggio, per muri di spessore maggiore a 120 mm, si inserisce tra gli stipiti.

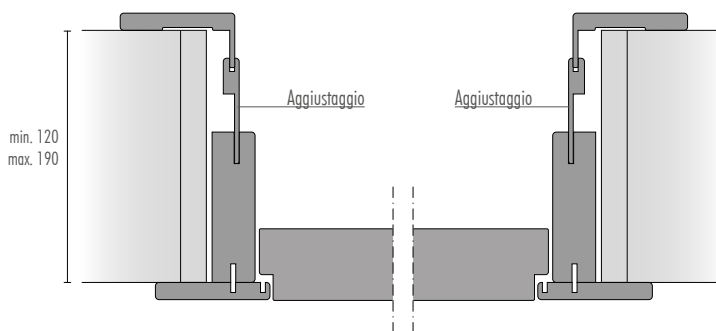
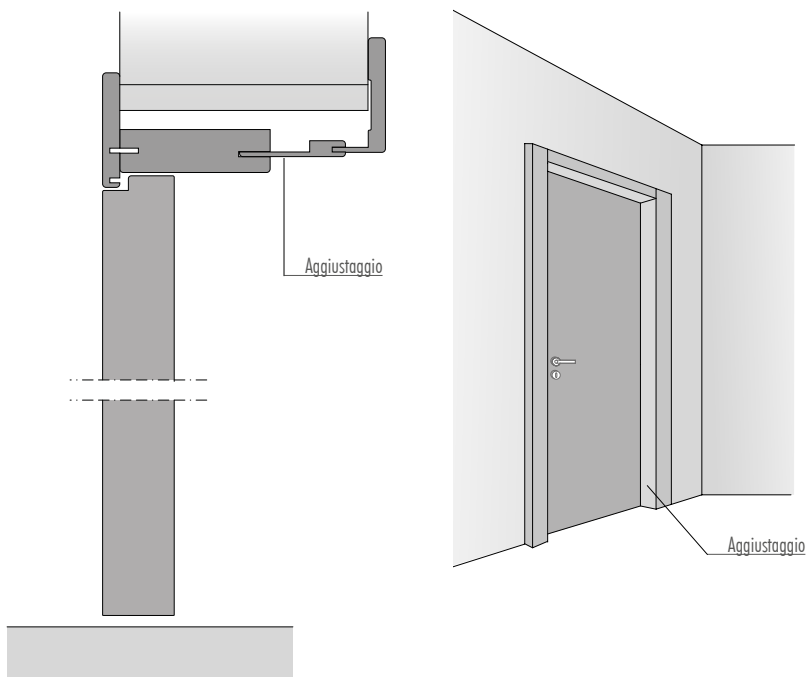

RIFILO STIPITI PER MURI DI SPESSORE INFERIORE A 105 mm

INDICAZIONE PER L' ORDINE:
Indicare spessore del muro

